



30W LED Slim Parking Garage Canopy Fixture

Parking Garage Luminaires

Features & Benefits:

- Great Energy Savings !
- 5-Years | 50,000 Hours Warranty (★)
- High Power Factor – UL Listed Driver
- Bright – High CRI – High Lumen Output
- Built-in Surge Suppressors & Protection
- CCT 5,000K ideal for MH Lamps Replacement



Optional: Integral Controls for Occupancy Sensing & Bi-level Dimming



Model	Product	Power	Size	Flux	Equivalent
PGF-30W-50K-277V	LED Parking Garage Canopy Fixture 30W 5000K	30W Max.	(L) 11" (W) 11" (H) 3½"	4,500 Lumen	HID 175W- 250W
PGF-30W-40K-277V	LED Parking Garage Canopy Fixture 30W 4000K				
PGF-30W-30K-277V	LED Parking Garage Canopy Fixture 30W 3000K				

- 120-277Vac ~50/60Hz • Pigtail Wire • P.F. > 0.9 • THD < 20% •
- "50K"=CCT 5000K, "40K"=CCT 4000K, "30"=CCT 3000K ±10% • CRI ≈ 82 • ~150 Lumen/W •
- (★) Rated Life > 50,000 Hrs. (L70 B50) at T[A]45°C Max. •
- Operating Temperature Range -20°F to 135°F (-30°C to 60°C) •

30W Parking Garage Canopy LED Luminaire

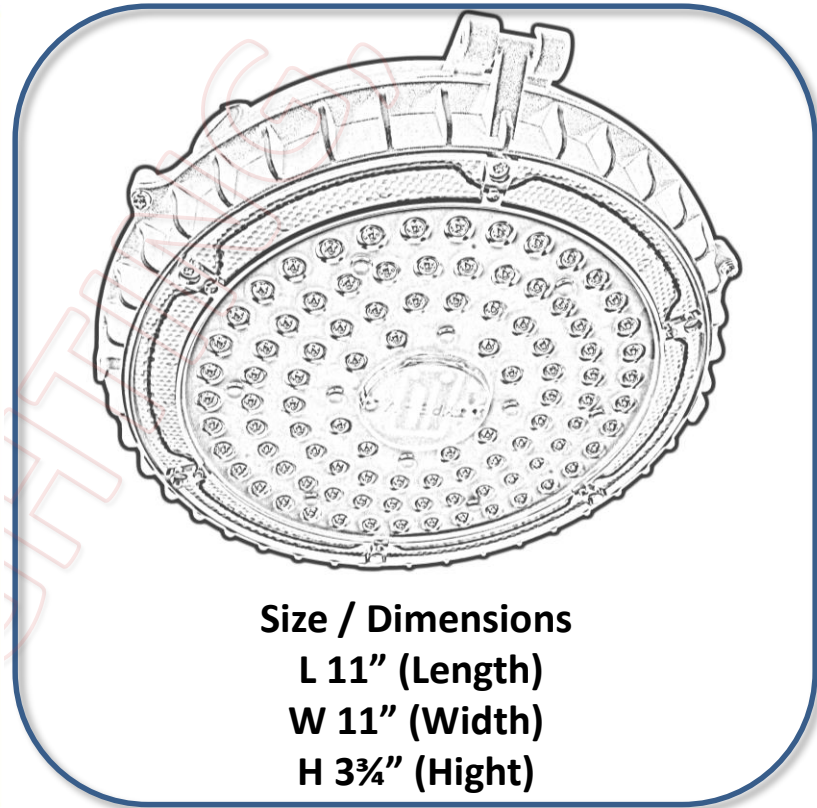
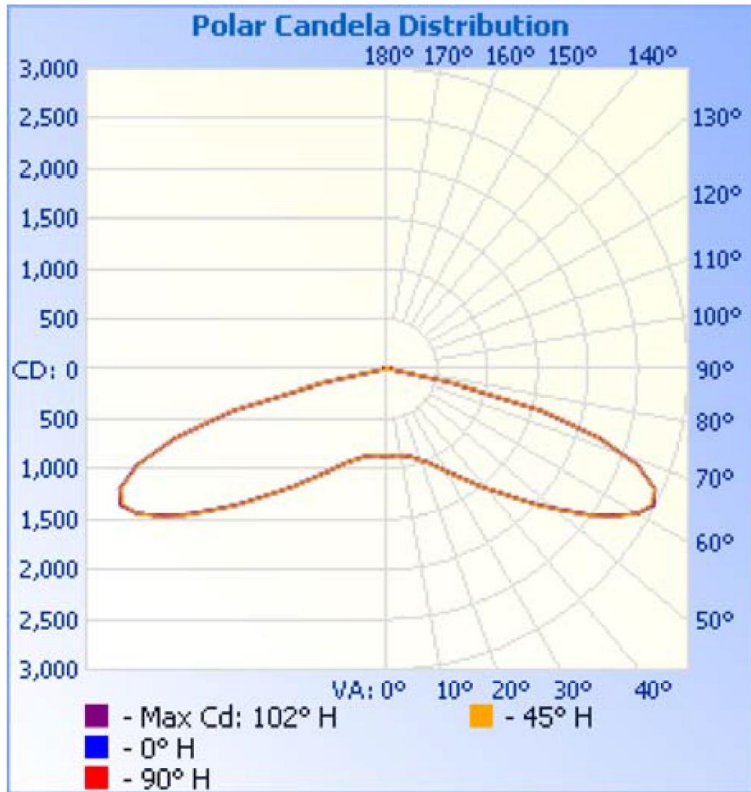

Model	Product	Power	Equivalent
PGF-30W-50K-277V	LED Parking Garage Canopy Fixture 30W 50K	30W Typ.	HID 175W/250W
Input Voltage	Power Factor / THD	Efficacy	Flux
120-277Vac ~50/60Hz	P.F. ≈ 0.93 THD < 20%	~150 lm/W	4,500 Lumen
Color Rendering	Color Temperature	Beam Angle	Life
CRI ≈ 85	CCT 5000K ±10%	~140°	50,000 Hours (L ₇₀ B ₅₀) T _[A] 45°C Max.